

HINTS & TIPS

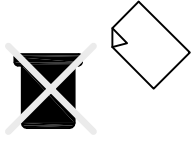

Assembly Instruction



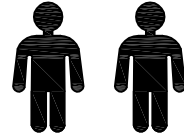
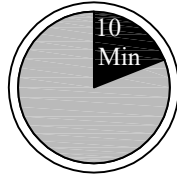

Please retain this assembly instruction for future use.

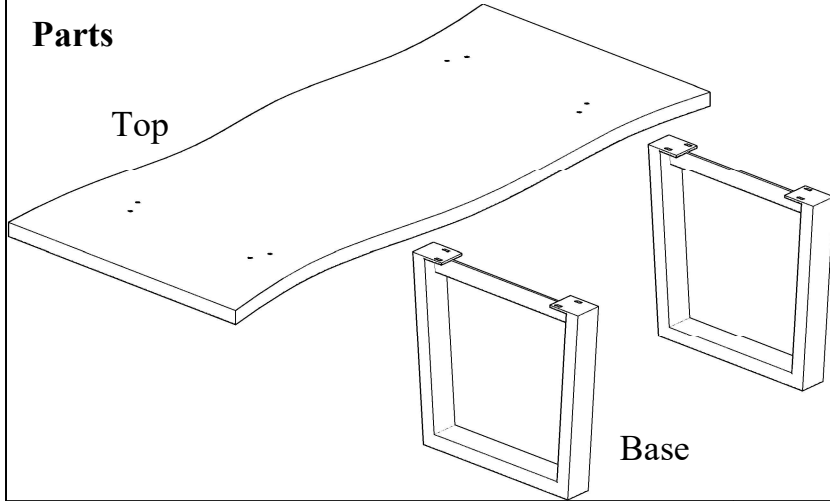

This assembly requires two people

Parts

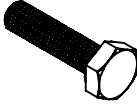
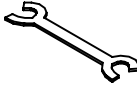

Code	Description	Qty
1	 Flat Washer	08
2	 Bolt	08
3	 Wrench	1

Step 1.

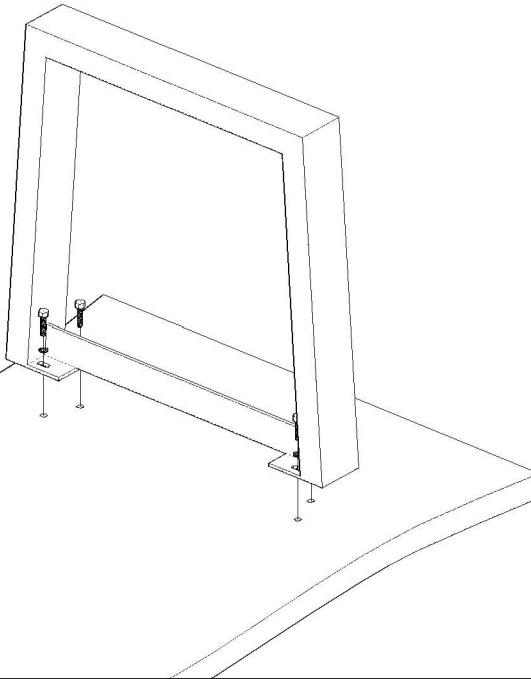

Step 2.

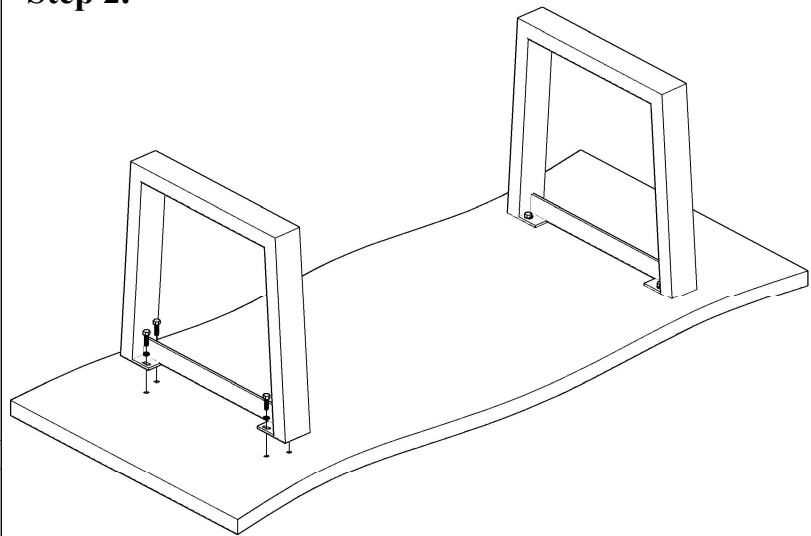

Step 3.

